

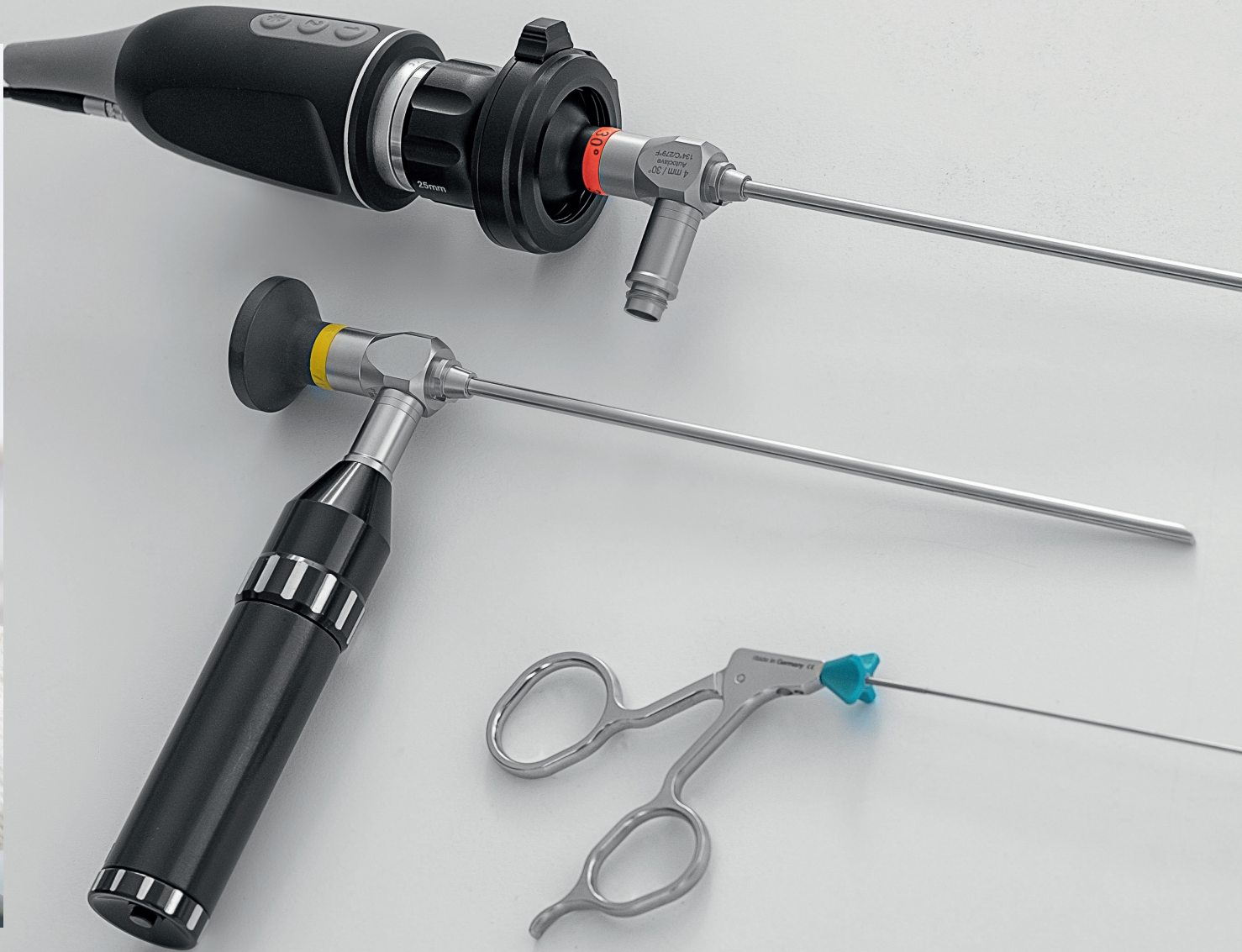

BURTONS

SPiTZ diagnostic endoscopy range





- Different scopes and sheaths for all kind of indications
- For diagnosis and treatment in all natural orifices
- Wide range of flexible, semiflexible and rigid instruments
- Dedicated equipment for the Rhinoscopy, Laryngoscopy, Otoscopy or Vaginoscopy and Cystoscopy
- Urethro-Cystoscopes for the artificial insemination



Mobile endoscopy becomes possible with this High Definition camera that allows endoscopic examination with all required parts in one complete set. Integrated illumination and a high-performance camera head, powered by an external Desktop-Computer or Laptop via USB 3.0 makes examination and clinical surgery possible.

- Full HD (1920 x 1080) recording function (images / video)
- Powered by USB connection (USB 3.0 required)
- Long-life LED illumination
- Programmable camera head with adjustable brightness
- Easy software installation and interface (Software incl. patient management/storage)
- Lightweight, ready-to use design



300-001-480
FULL HD CAMERA SET
consisting of:

- A Camera head
- B Endoscope coupler
- C Light source
- D Suitcase
- E Software



High-Performance
HD Camera Head



Programmable buttons and
adjustable brightness button

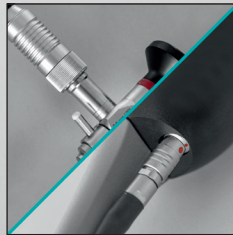

Light source can be connected
directly to endoscope and
camera head



Just a USB 3.0 port is
required





Otoscope, 5 Charr., Ø4mm, 65mm working length
0° 410-005-000

Semi-rigid Instruments

- 280mm working length
- 5 Charr.



Stone Grasping Forceps, double action
253-200-128



Large Stone Grasping Forceps, double action
253-200-228



Biopsy Forceps, double action
253-200-328



Cotton Applicator, rough spiral end, Ø1.5mm
180mm 160-412-180



Farrell Cotton Applicator, triangular, Ø0.9mm
120mm 160-426-120
140mm 160-426-140

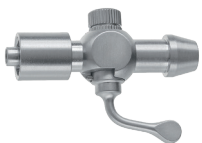

LuerLock tube connector with stopcock
300-011-179



LuerLock one-way stopcock
300-011-515

ENT

Otoscopy



Hartmann Aural Forceps, straight, serrated

1 x 8mm

410-210-085

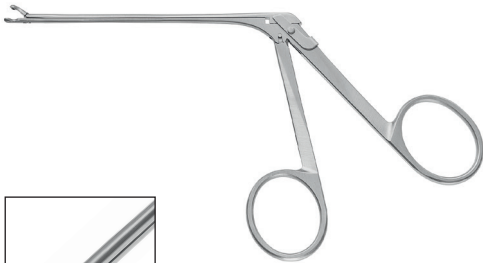

Hartmann-Herzfeld Ear Forceps, straight,
87mm working length

2.5mm spoon

410-338-136

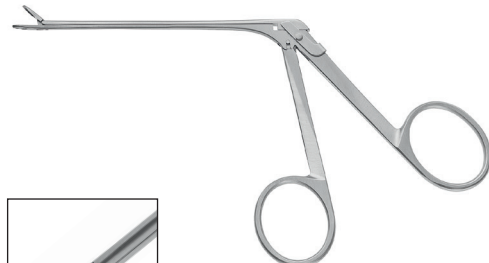

Struempel Ear Forceps, straight,
87mm working length

2.5 x 7.0mm

410-338-134



Ormerod Micro Cupped Forceps, straight,
round cup, 80mm working length

3.0 x 1.7mm

410-423-000

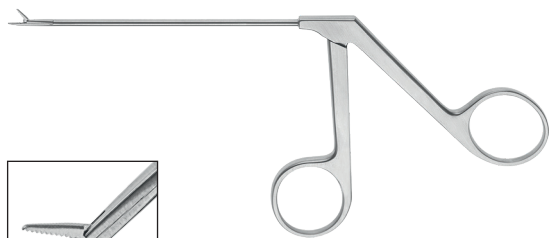

Micro Aural Forceps with tubular shaft, straight
80mm working length

0.8 x 3.5mm

410-330-000



Troeltsch Aural Tissue Forceps, 1x2 teeth,
knee bent

125mm

410-377-120



House Curette, sharp, double ended, oval cups,
strongly curved, 1.0 x 1.2mm

150mm

410-330-000



Williger Double Curette, oval/oval
#0 / 1 (Ø 3.0 / 3.5mm)

140mm

210-216-001



ENT

Rhino/Naso

Rhinology / Nasopharyngeal Endoscopy

Equipment and instruments for the visualization in
the nasopharyngeal area

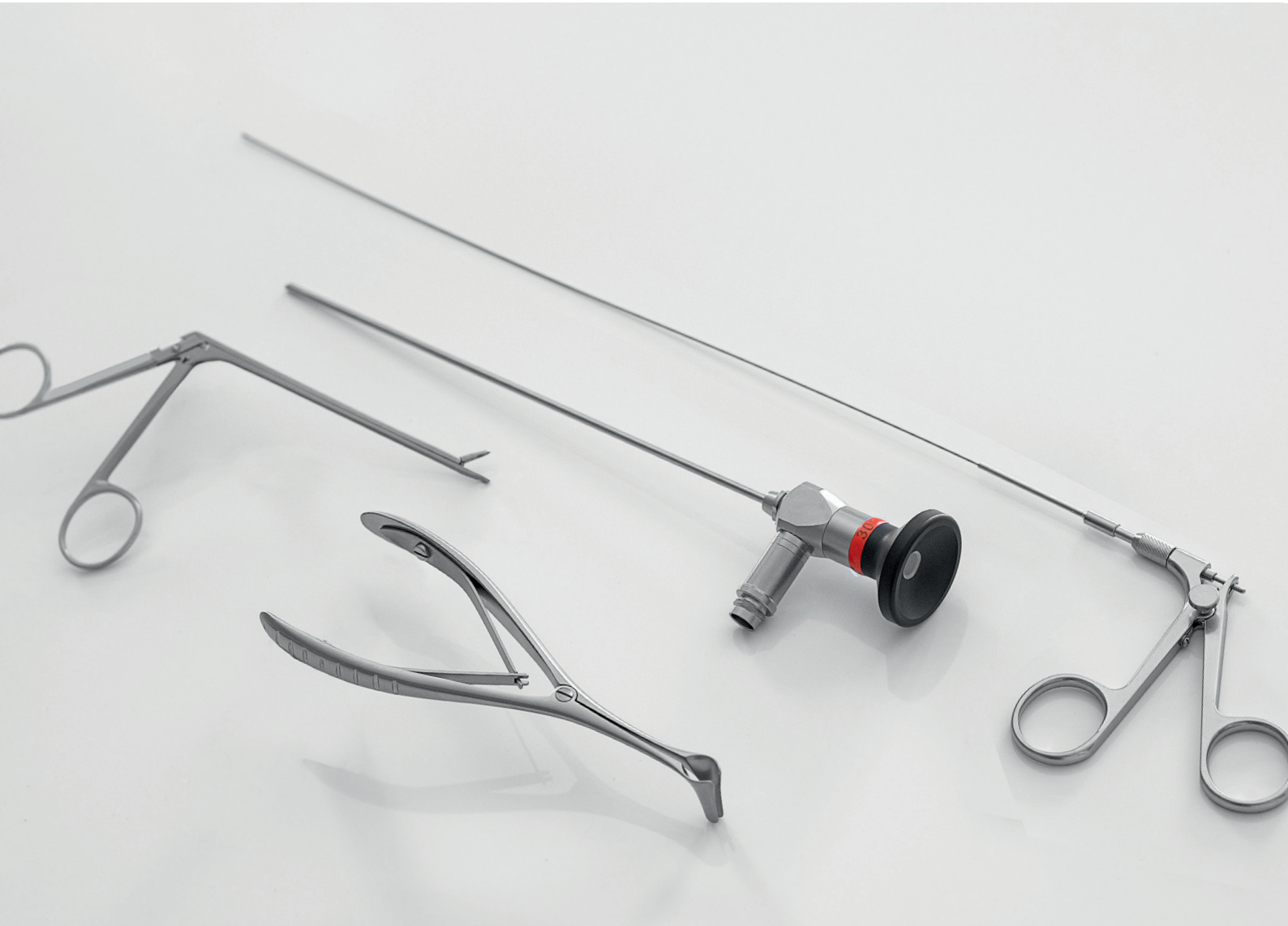



Set for
DOGS
Ø2.7mm

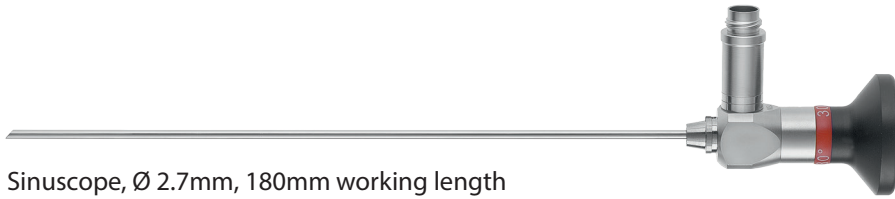

Sinuscope, Ø 2.7mm, 180mm working length

- 0° 252-127-000
- 30° 252-127-030
- 70° 252-127-070

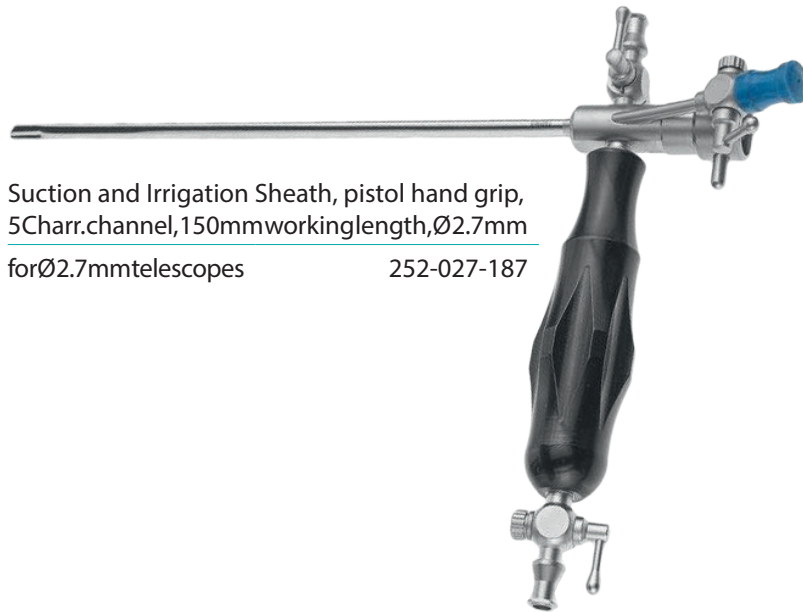

Suction and Irrigation Sheath, pistol hand grip,
5Charr.channel, 150mm working length, Ø2.7mm
for Ø2.7mm telescopes 252-027-187

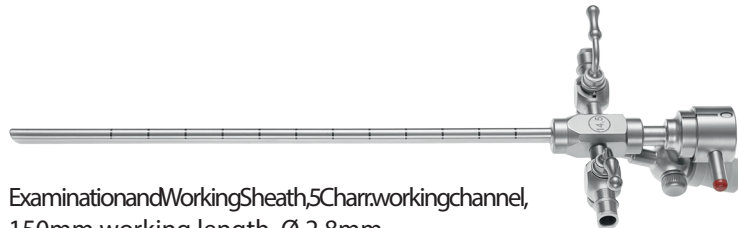

Examination and Working Sheath, 5Charr. working channel,
150mm working length, Ø 2.8mm
for Ø2.7mm telescopes 252-027-185



Cleaning brush, flexible, Ø2.5mm
120cm length, for 5Charr working channel

253-961-102



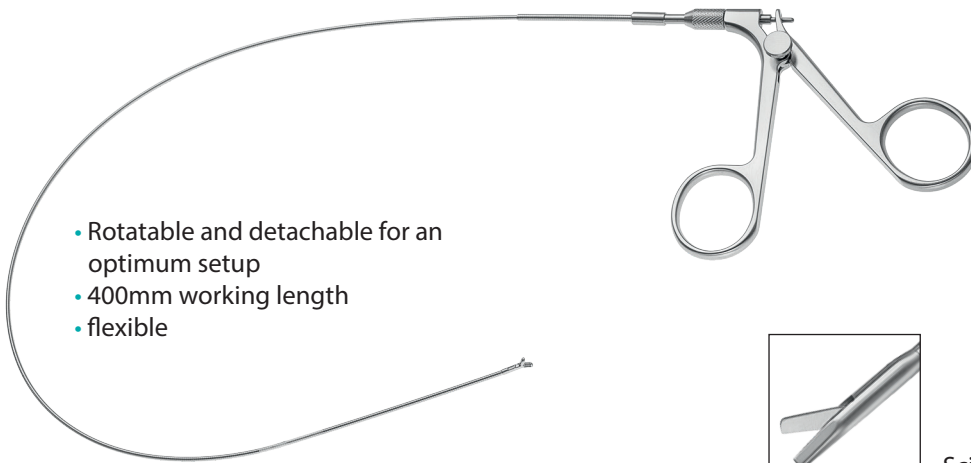

- Rotatable and detachable for an optimum setup
- 400mm working length
- flexible



FLEXIBLE

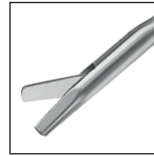

Scissors, single action

5 Charr.

351-100-105



Grasping Forceps, serrated jaws, double action

5 Charr.

351-114-105



Biopsy Forceps, oval cup, double action

5 Charr.

351-120-105

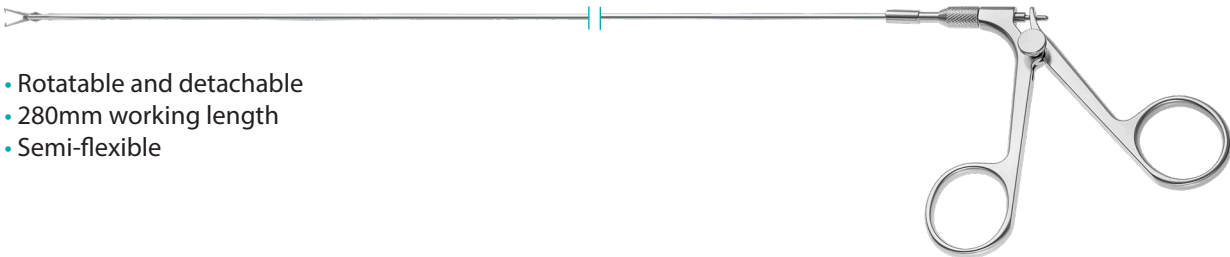

- Rotatable and detachable
- 280mm working length
- Semi-flexible



SEMI FLEXIBLE

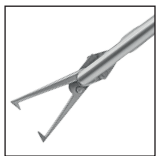

Large Stone Grasping Forceps, double action

5 Charr.

253-200-228



Scissors, single action

5 Charr.

253-200-228



FLEXIBLE

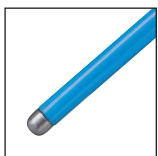

Ball Electrode, monopolar, 530mm length

5 Charr.

253-370-005

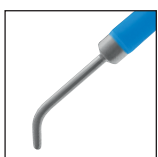

Needle Electrode, monopolar, 530mm length

5 Charr.

253-371-005

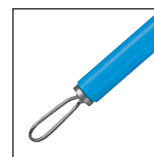

Loop Electrode, monopolar, 250mm length

5 Charr.

253-372-005



Set for
CATS

Ø2.0mm

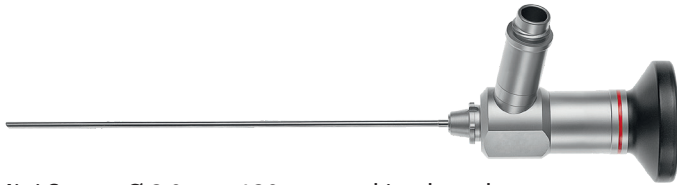

Mini Scope, Ø 2.0mm, 120mm working length

0° 253-221-000

30° 253-221-030

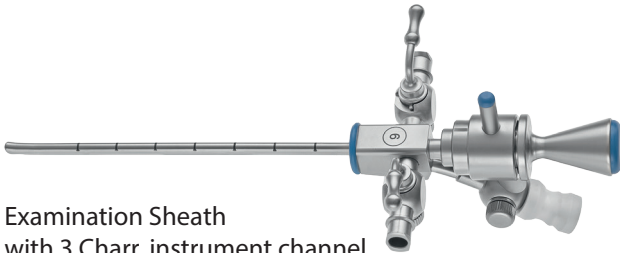

Examination Sheath
with 3 Charr. instrument channel,
atraumatic tip

9 Charr. / 3mm 253-200-009

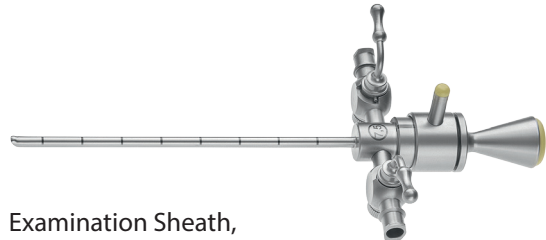

Examination Sheath,
atraumatic tip

7.5 Charr. / 2.5mm 253-200-007

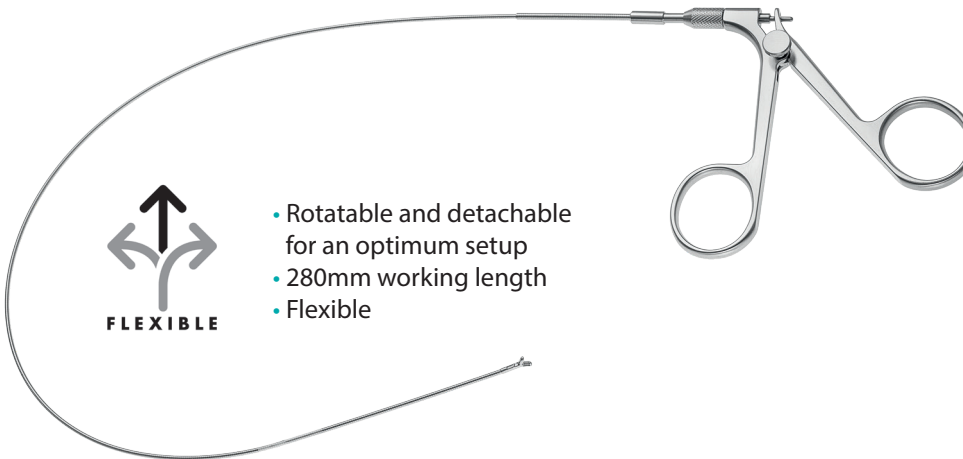

- Rotatable and detachable for an optimum setup
- 280mm working length
- Flexible



Alligator Grasping Forceps, double action

3 Charr. 253-202-003



Biopsy Forceps, double action

3 Charr. 253-204-003

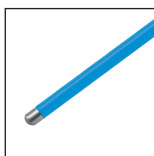

Ball Electrode, monopolar, 250mm length

3 Charr. 253-370-253

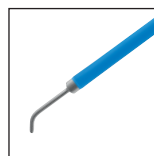

Needle Electrode, monopolar, 250mm length

3 Charr. 253-371-253





*Visualization
with minimal equipment*

LED Portable Light Source, with 1700mAh charger

300-001-183





Instruments for endoscopically assisted and open treatment



Halle-Tieck Nasal Speculum, screw joint, 130mm total length
17.5mm blade length 420-140-135



DJ Forceps, double action
7 Charr. 351-107-107

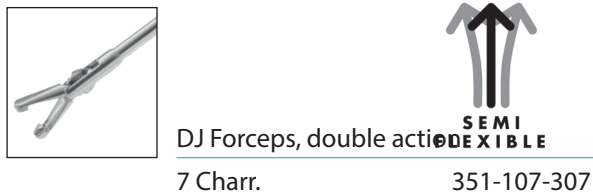

DJ Forceps, double action
7 Charr. 351-107-307

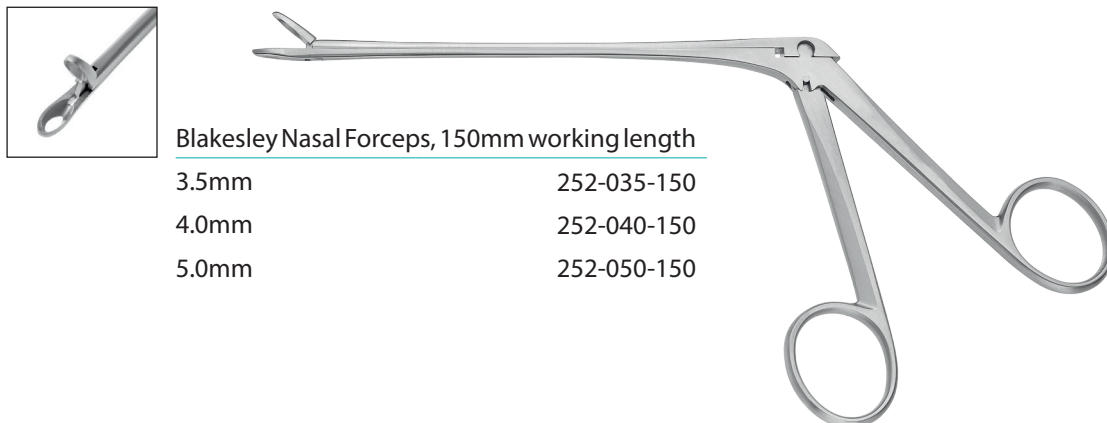

Blakesley Nasal Forceps, 150mm working length
3.5mm 252-035-150
4.0mm 252-040-150
5.0mm 252-050-150





Noyes Nasal Forceps, 115mm working length
fenestrated jaw 252-527-115



Biopsy and Grasping Forceps, delicate pattern,
140mm working length
3mm oval cup 252-503-140

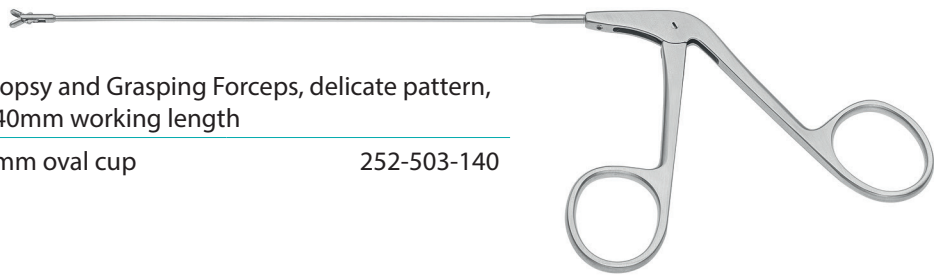

Struempel Nasal Forceps with
oval fenestrated cupped jaws
120mm working length



straight 252-031-120

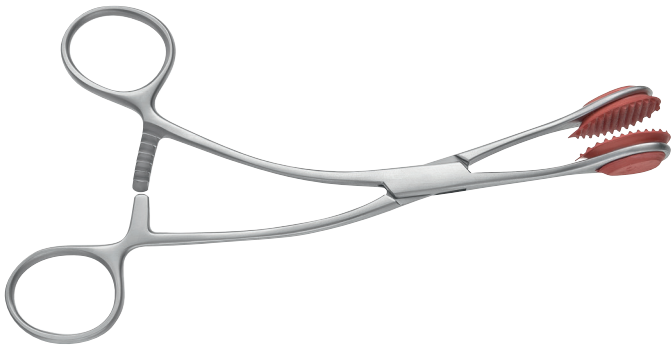

Young Tongue Holding Forceps

170mm

430-467-170



Hurd Elevator

230mm

430-522-230



Green Retractor, 20 x 23mm

220mm

170-319-220



Lange Choana Hook

230mm

420-413-230



Laryngeal mirror with hexagonal handle, 180mm

Fig. 00, Ø8mm	230-330-008
Fig. 1, Ø12mm	230-330-012
Fig. 3, Ø16mm	230-330-016
Fig. 5, Ø20mm	230-330-020

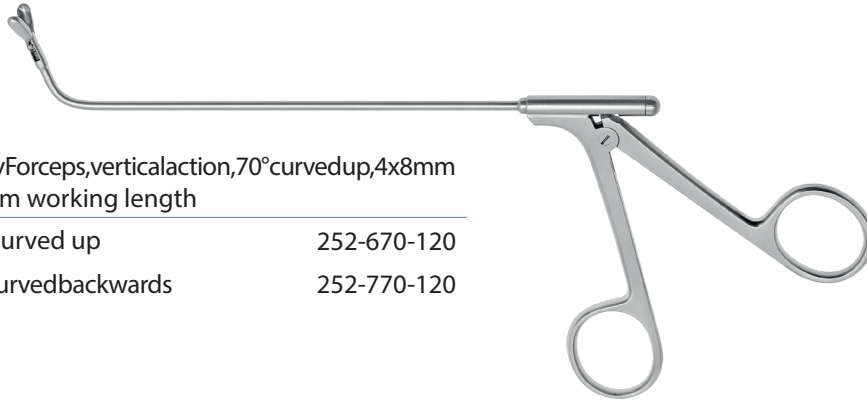

Biopsy Forceps, vertical action, 70° curved up, 4x8mm
130mm working length

70° curved up	252-670-120
110° curved backwards	252-770-120





Bronchoscopy/ Esophago-Gastroscopy

Instruments and rigid scopes for the respiratory
and gastrointestinal area



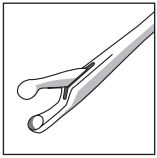
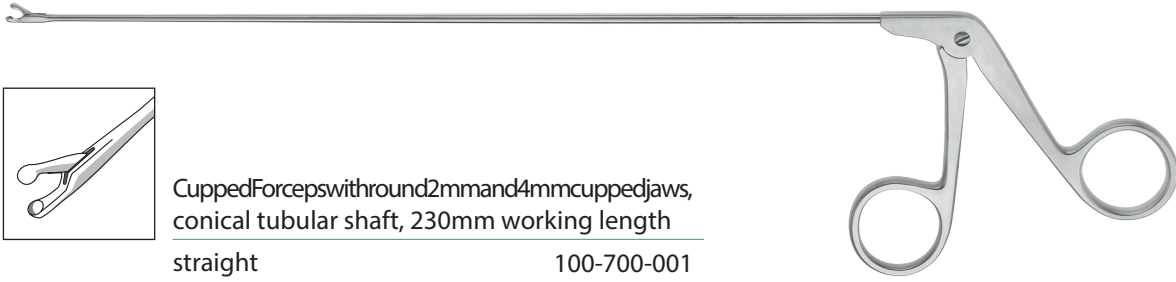

Cupped Forceps with round 2mm and 4mm cupped jaws,
conical tubular shaft, 230mm working length
straight 100-700-001

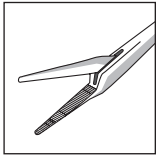

Alligator Forceps, standard model, conical tubular shaft 2mm,
230mm working length
straight, serrated 100-700-020

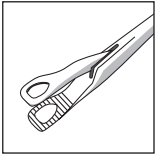

Alligator Forceps, standard model, conical tubular shaft 2mm,
triangular jaws, 230mm working length
straight 100-700-026

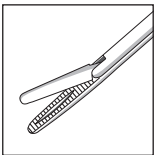
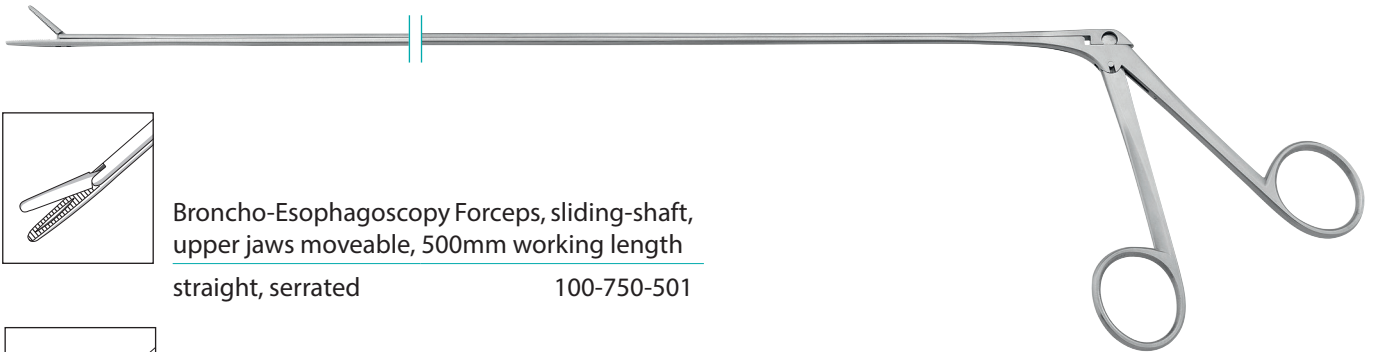

Broncho-Esophagoscopy Forceps, sliding-shaft,
upper jaws moveable, 500mm working length
straight, serrated 100-750-501

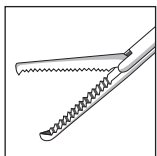

straight, 1x2 teeth 100-750-502

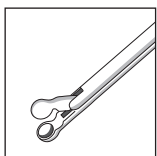

straight, cupped jaws 100-750-504

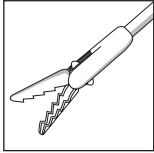
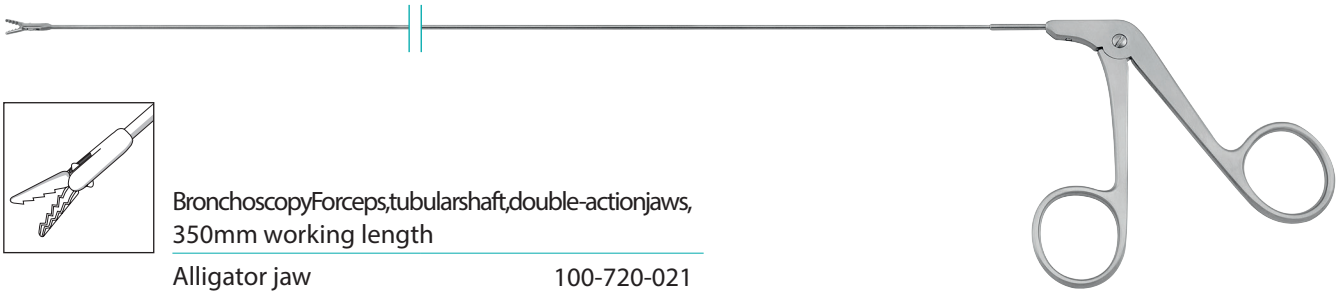

Bronchoscopy Forceps, tubular shaft, double-action jaws, 350mm working length

Alligator jaw 100-720-021

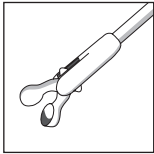

Bronchoscopy Forceps, tubular shaft, double-action jaws, biopsy cup, 350mm working length

straight, round cup 100-720-023



Bronchoscope, rigid, 540mm working length, 30°

Ø 5.5mm 100-655-100

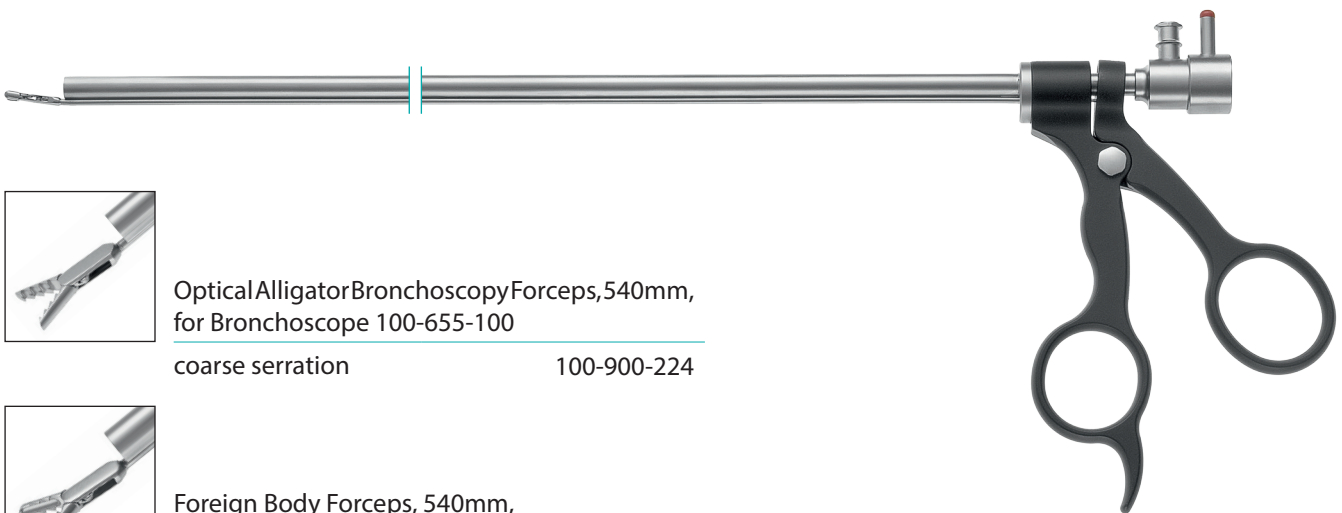

Optical Alligator Bronchoscopy Forceps, 540mm, for Bronchoscope 100-655-100

coarse serration 100-900-224



Foreign Body Forceps, 540mm, for Bronchoscope 100-655-100

100-900-227



360° rotatable, color-coded instruments, 5 Charr.

- 360° rotatable, just with your finger tip
- Corrosion resistance due to lotus effect
- Self-holdig grasping forceps



600mm working length,
flexible



340mm working length,
semi-flexible



Stone Grasping Forceps,
double action jaw

■ knob color 253-951-005

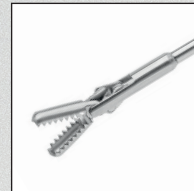

Grasping Forceps, with cup,
serrated, double action jaw

■ knob color 351-116-335



Stone Grasping Forceps,
large stones, double action jaw

■ knob color 253-953-005

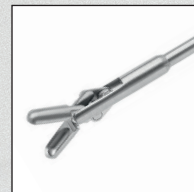

Biopsy Forceps,
double action

■ knob color 351-120-335



Hamada Long Stone Grasping
Forceps, double action jaw

■ knob color 253-955-005



Tenaculum Forceps, 1x1 teeth,
double action jaw

■ knob color 351-117-335



Biopsy Forceps,
double action jaw

■ knob color 253-957-005



Scissors, single action jaw

■ knob color 253-959-005

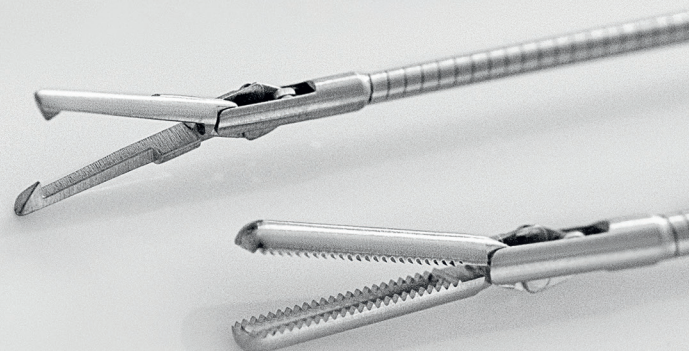



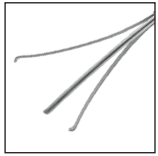

StoneGraspingForceps,rigid,400mmworking length,tripletoothedjaw,U-springhandle
5 Charr. 253-960-360



StoneGraspingForcepswithspringhandleand fingerplatform,Ø4mm,Luer-Lockconnection fenestrated jaws
360mm 253-900-205
450mm 253-900-245



StoneGraspingForcepswithspringhandleand fingerplatform,Ø4mm,Luer-Lockconnection, 3 prongs
360mm 253-900-206
450mm 253-900-246

Accessories for flexible endoscopes



3 prongs Grasper,
600mm working length

Ø1.8mm,600mmworkinglength 253-940-005



Foregin Body Retriever, 2x2 teeth

Ø1.8mm,2300mmworkinglength 310-970-230

Ø2.3mm,2300mmworkinglength 310-971-230

Ø2.3mm,1200mmworkinglength 310-971-120

2x1 teeth

Ø2.3mm,2300mmworkinglength 310-973-230

Ø1.8mm,1800mmworkinglength 310-972-180



3 prongs Retriever, round

Ø1.8mm,1800mmworkinglength 310-981-180

Ø1.8mm,2300mmworkinglength 310-981-230

Ø2.3mm,1800mmworkinglength 310-982-180

Ø2.3mm,2300mmworkinglength 310-982-230



4 prongs Retriever, sharp

Ø2.3mm,2300mmworking length 310-983-230



**Long Oval Cup, serrated**

Ø1.8mm,1200mmWL	310-935-120
Ø1.8mm,1800mmWL	310-935-180
Ø2.3mm,1200mmWL	310-937-120
Ø2.3mm,1600mmWL	310-937-160
Ø2.3mm,1800mmWL	310-937-180
Ø2.3mm,2300mmWL	310-937-230

**Long Oval Cup, fenestrated**

Ø1.0mm,1200mmWL	310-901-120
Ø1.4mm,1600mmWL	310-902-160
Ø1.6mm,1600mmWL	310-903-160
Ø1.8mm,1800mmWL	310-904-180
Ø2.3mm,2300mmWL	310-906-230

**Biopsy Forceps, oval cup with fine teeth**

Ø1.8mm,1200mmWL	310-944-120
Ø1.8mm,1800mmWL	310-944-180
Ø2.3mm,1600mmWL	310-945-160
Ø2.3mm,2300mmWL	310-945-230

**Long Oval Cup, fenestrated, with needle**

Ø1.8mm,1200mmWL	310-907-120
Ø1.8mm,1600mmWL	310-907-160
Ø2.1mm,1600mmWL	310-908-160
Ø2.3mm,2300mmWL	310-909-230

**Round Cup, fenestrated**

Ø2.3mm,1800mmWL	310-930-180
Ø2.9mm,1200mmWL	310-930-120
Ø3.4mm,2300mmWL	310-931-230

**Alligator Forceps**

Ø1.0mm,1200mmWL	310-960-120
Ø1.4mm,1600mmWL	310-961-160
Ø1.6mm,1600mmWL	310-962-160
Ø1.6mm,1800mmWL	310-962-180
Ø1.8mm,1800mmWL	310-963-180
Ø1.8mm,2300mmWL	310-963-230
Ø2.3mm,1800mmWL	310-964-180
Ø2.3mm,2300mmWL	310-964-230
Ø3.0mm,2300mmWL	310-965-230

**Rat Tooth, 2x1 teeth**

Ø1.8mm,1200mmWL	310-952-120
Ø1.8mm,1800mmWL	310-952-180
Ø2.3mm,1600mmWL	310-953-160
Ø2.3mm,2300mmWL	310-953-230
Ø3.0mm,2300mmWL	310-954-230

WL=working length

Forceps with other diameter and length are available on request



Dormia Metal Stone Basket

7Charr.,1800mmWL	253-585-187
7Charr.,2300mmWL	253-585-237
5Charr.,1800mmWL	253-585-185
5Charr.,2300mmWL	253-585-235
5 Charr., 600mm WL	253-585-005

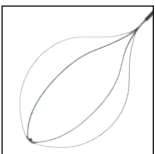
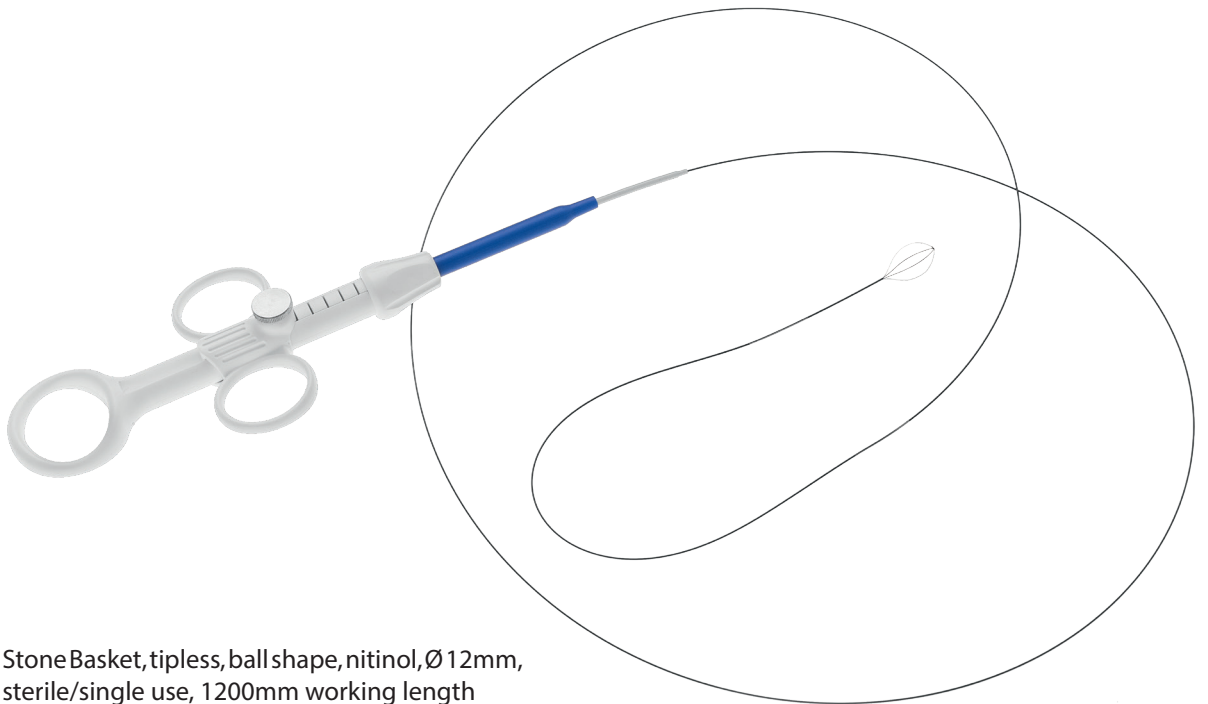

Stone Basket, tipless, ball shape, nitinol, Ø12mm, sterile/single use, 1200mm working length

1.3 Charr.	253-960-013
1.9 Charr.	253-960-019

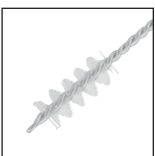

Brush for Cystology, 3.0 Charr., single use, package of 5 pieces

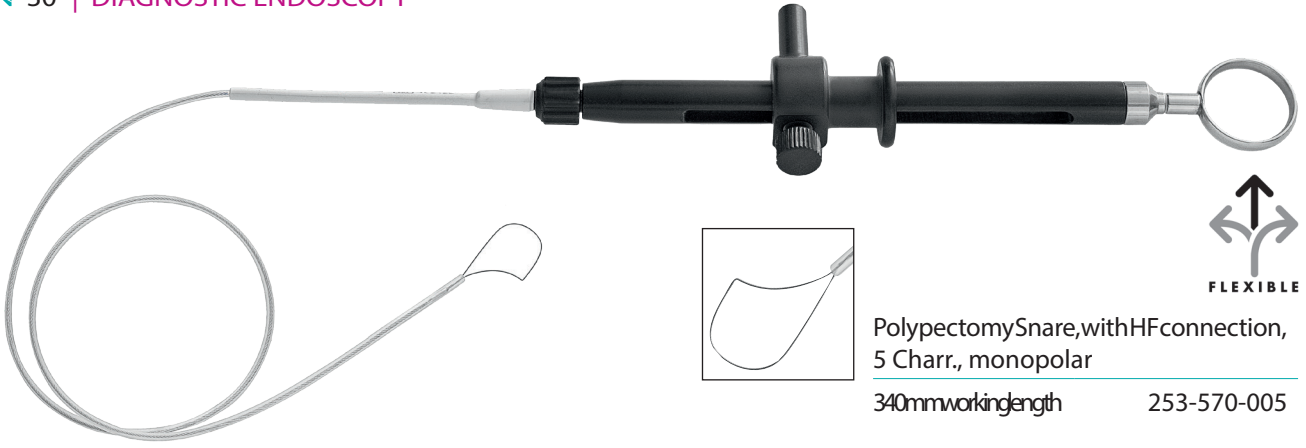
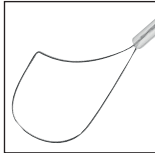

3.0 Charr.	253-962-003
------------	-------------

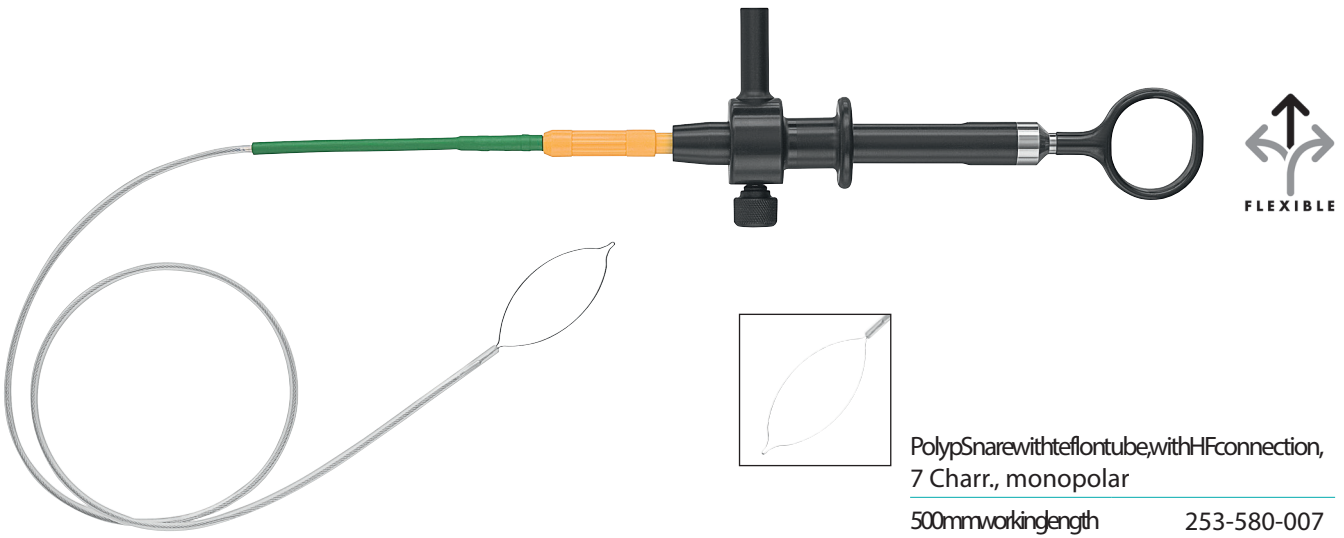
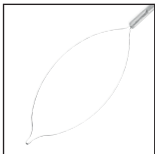

Polypectomy Snare, with HF connection,
5 Charr., monopolar
340mm working length 253-570-005

Polyp Snare with teflon tube, with HF connection,
7 Charr., monopolar
500mm working length 253-580-007

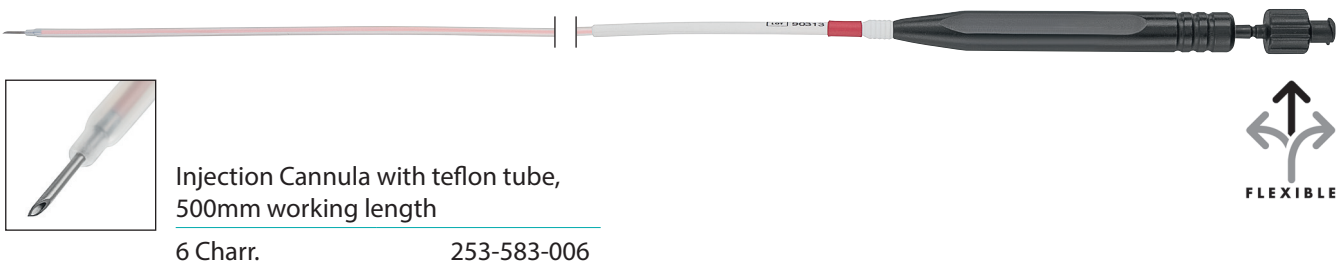
Injection Cannula with teflon tube,
500mm working length
6 Charr. 253-583-006

Flexible Ball Electrode, monopolar,
115cm working length
3 Charr. 253-370-103

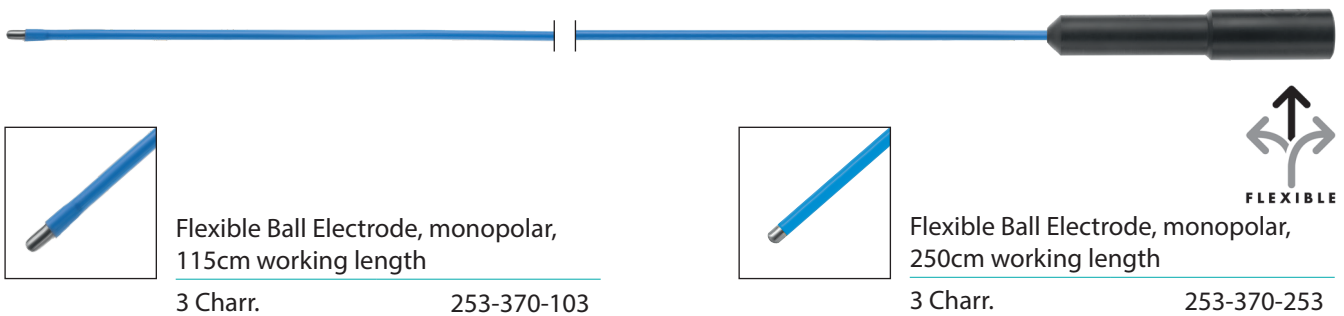
Flexible Ball Electrode, monopolar,
250cm working length
3 Charr. 253-370-253

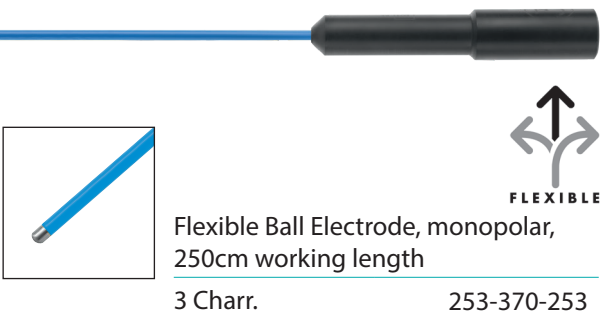
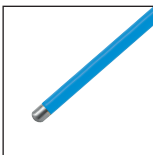

Urology/Vaginoscopy
Hysteroscopy





SMALL

Ø2.0mm



Cystoscope, Ø 2.0mm, 120mm working length

0° 253-221-000

30° 253-221-030

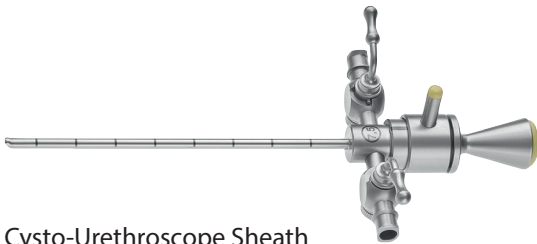

Cysto-Urethroscope Sheath

7.5 Charr. 253-200-007

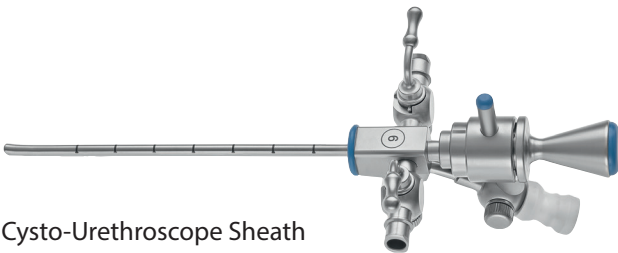

Cysto-Urethroscope Sheath
with 3 Charr. Instrument Channel

9 Charr. 253-200-007



LARGE

Ø2.7mm

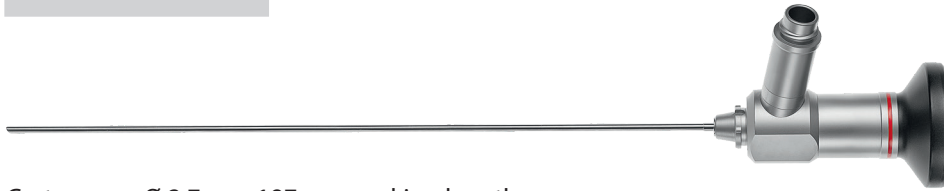

Cystoscope, Ø 2.7mm, 187mm working length

0° 253-227-000

30° 253-227-030



Cystoscope Sheath, with 3 Charr. working channel

11 Charr. 253-220-011

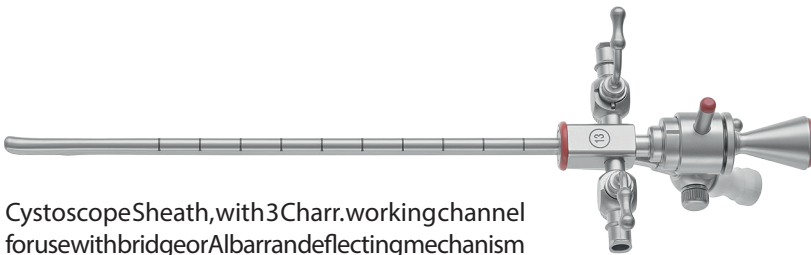

Cystoscope Sheath, with 3 Charr. working channel
for use with bridge or Albarran deflecting mechanism

13 Charr. 253-220-014

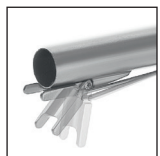
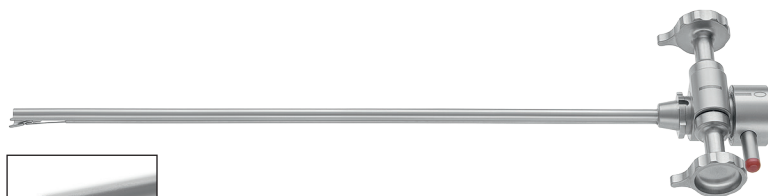
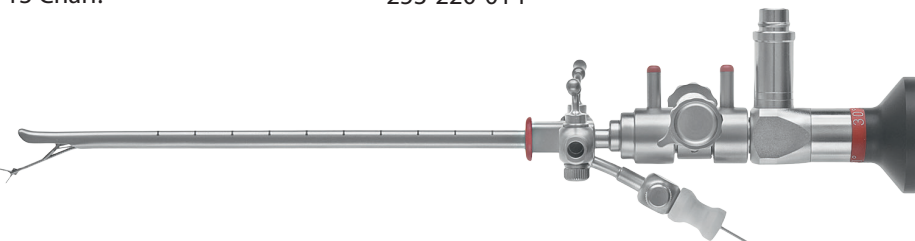

Albarran deflecting mechanism

for use with 253-220-014 253-220-025

for use with 3 Charr. 253-202-003

Instruments + 253-204-003



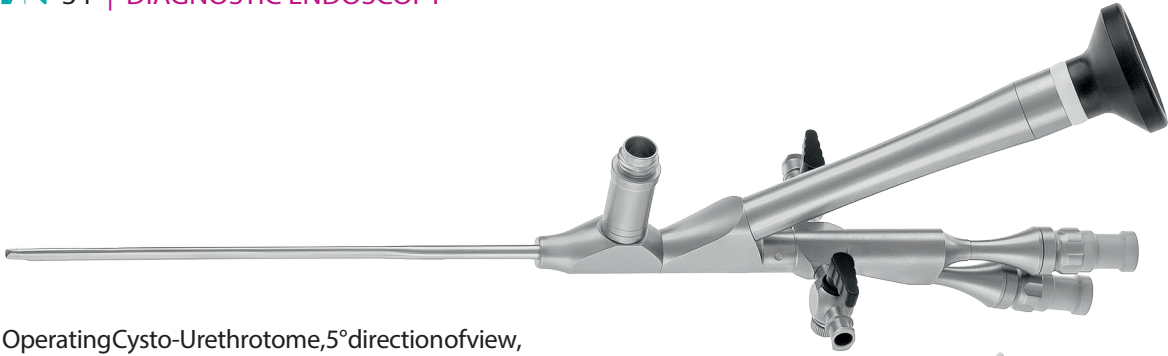

Operating Cysto-Urethrotome, 5° direction of view,
2 lateral suction/irrigator connections, 140mm working length

6.0 Charr./5.0 Charr. working channel 253-200-600

4.5 Charr./3.5 Charr. working channel 253-200-500



Silicone Valve

pack of 5 pcs.

253-905-400

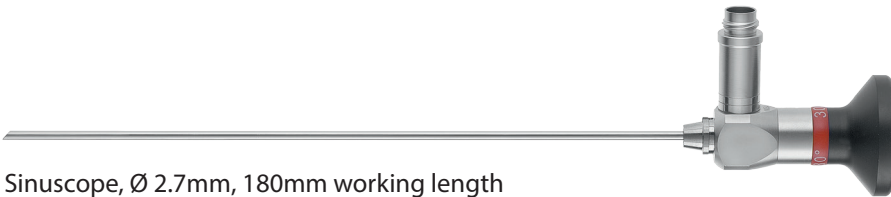

Sinuscope, Ø 2.7mm, 180mm working length

30° 252-127-030

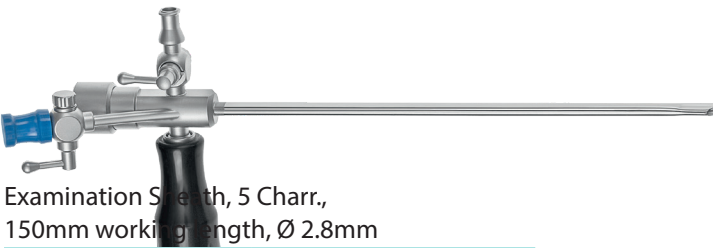

Examination Sheath, 5 Charr.,
150mm working length, Ø 2.8mm

for 30° telescope 252-027-185

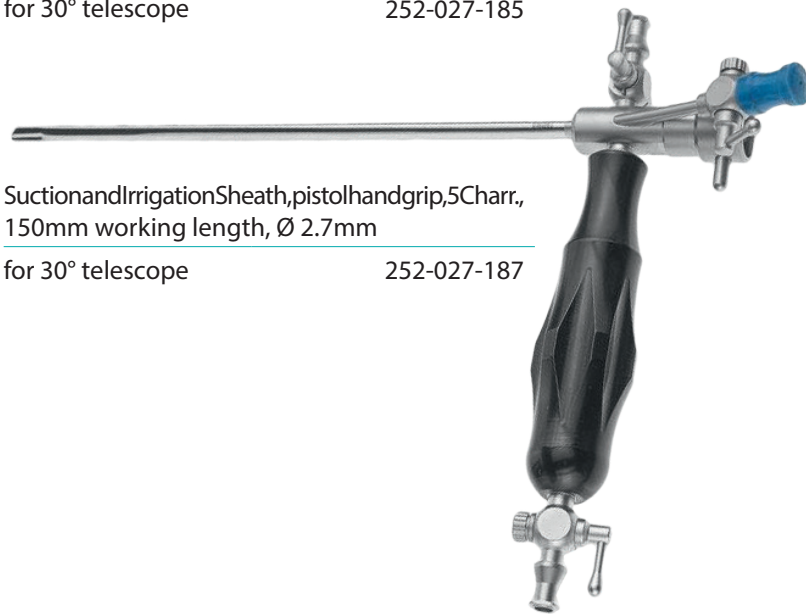

Suction and Irrigation Sheath, pistol hand grip, 5 Charr.,
150mm working length, Ø 2.7mm

for 30° telescope 252-027-187

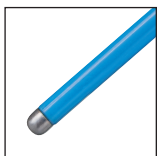

Ball Electrode, monopolar, 530mm length

5 Charr.

253-370-005

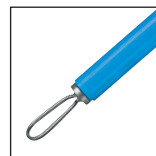

Loop Electrode, monopolar, 530mm length

5 Charr.

253-372-005





Killian Specula, 145mm

36 x 7mm	420-145-036
75 x 7mm	420-145-075



Cottle Specula with set-screw, 135mm

38mm	420-136-035
70mm	420-136-070



St. Clair Thompson Specula, 73mm

38mm	420-052-001
65mm	420-002-003



Artificial Insemination

Advanced Semi-Rigid Uretero-Renoscope

425mm working length 253-905-540

Distal tip	7.0 Charr.
Distal	8.0 Charr.
Proximal	9.5 Charr.
Working channel	5.8 Charr.
<small>(for use with instruments up to 5 Charr.)</small>	
Field of view	65°
Direction of View	5°

slimLINE

Advanced Semi-Rigid Uretero-Renoscope

425mm working length 253-910-540

Distal tip	6.0 Charr.
Distal	7.0 Charr.
Proximal	7.5 Charr.
Working channel	5.0 Charr.
<small>(for use with instruments up to 5 Charr.)</small>	
Field of view	65°
Direction of View	5°

superslimLINE

Advanced Semi-Rigid Uretero-Renoscope

425mm working length 253-915-540

Distal tip	4.5 Charr.
Distal	5.0 Charr.
Proximal	6.0 Charr.
Working channel	4.0 Charr.
<small>(for use with instruments up to 5 Charr.)</small>	
Field of view	65°
Direction of View	5°



Transurethral injection



Cystoscope, Ø4.0mm, 300mm working length
12° 253-804-012

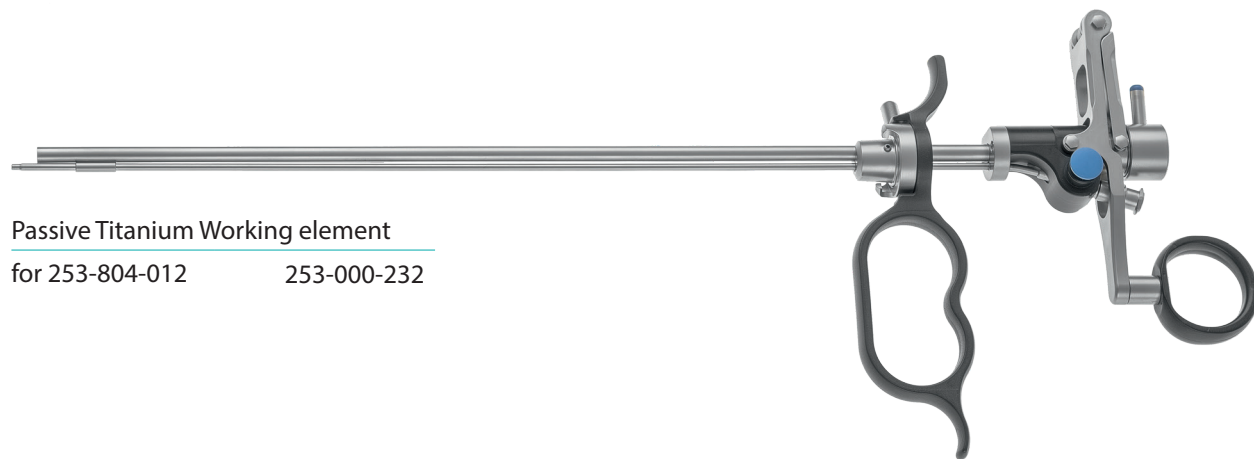

Passive Titanium Working element
for 253-804-012 253-000-232

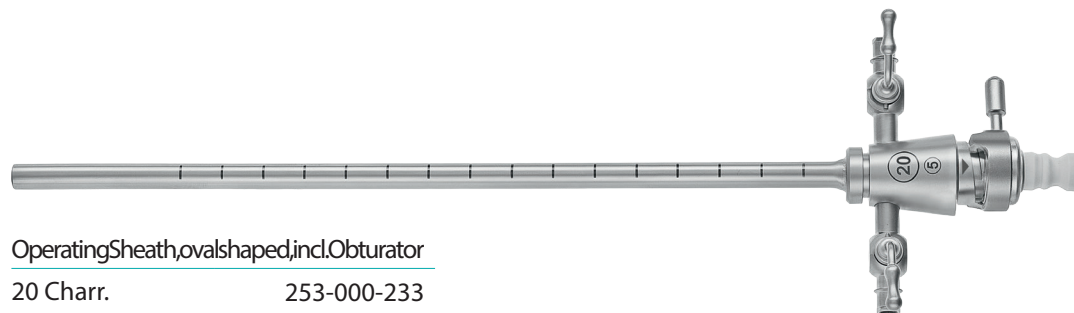

Operating Sheath, oval shaped, incl. Obturator
20 Charr. 253-000-233



Injection Cannula, semi-rigid, 2 Charr. distal end with rotatable Luer-Lock Adapter
4 Charr. 253-000-235



Exotic Animals

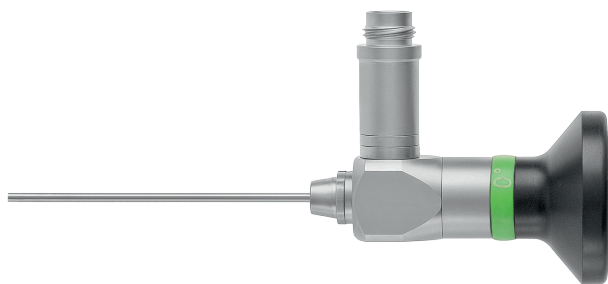

Micro Scope, Ø 1.7mm, 58mm working length
0° 225-017-000

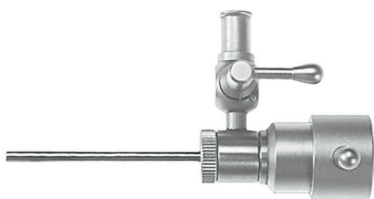

Micro Sheath,
1 stopcock, Ø 2.3mm, 36mm working length
for 225-017-000(0°) 225-217-036



**EASY
ILLUMINATION**



LED Portable Light source, with 1700mAh charger
300-001-183



Mini Scope, Ø 2.0mm, 120mm working length

- | | |
|-----|-------------|
| 0° | 253-221-000 |
| 30° | 253-221-030 |

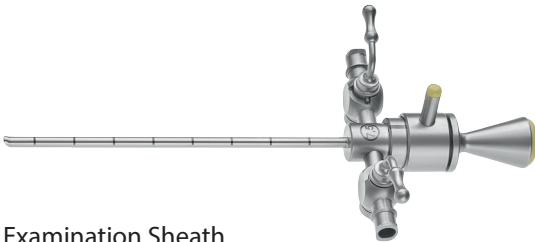

Examination Sheath

- | | |
|------------|-------------|
| 7.5 Charr. | 253-200-007 |
|------------|-------------|

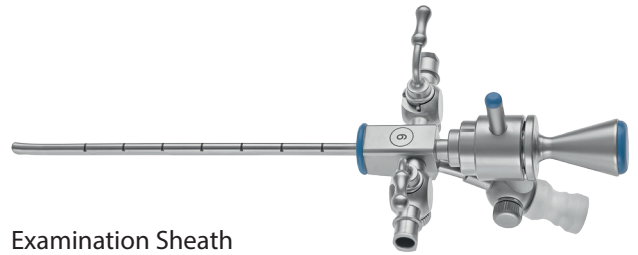

Examination Sheath
with 3 Charr. instrument channel

- | | |
|----------|-------------|
| 9 Charr. | 253-200-009 |
|----------|-------------|

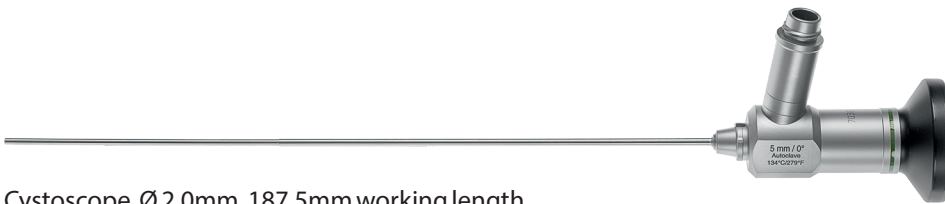

Cystoscope, Ø 2.0mm, 187.5mm working length

- | | |
|-----|-------------|
| 0° | 253-219-100 |
| 30° | 253-219-130 |



Cystoscope Sheath

- | | |
|------------|-------------|
| 7.5 Charr. | 253-200-075 |
|------------|-------------|

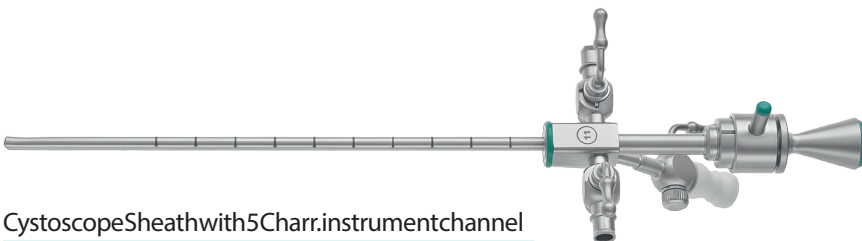

Cystoscope Sheath with 5 Charr. instrument channel

- | | |
|-----------|-------------|
| 11 Charr. | 253-200-011 |
|-----------|-------------|